



SPORT ORDER FORM

860 E. Parkridge Avenue, Corona, CA 92879

Tel: 951-808-9131 Fax: 951-808-9949

Toll Free: 800-892-8998 www.colourswheelchair.com

BILL TO

Company _____	P.O.# _____	Date _____	S/N _____	For Office Use Only
Completed by _____	Address _____			
Email Address _____				
City _____	State _____	Zip _____	Phone _____	Fax _____
Disability _____	Weight _____	Height _____		
Customer Name _____	Client Signature X _____	Email _____		

SHIP TO

Name _____	Company _____	Phone _____
Address _____	City _____	State _____ Zip _____

A MEASUREMENTS

FRAME

- Frame Length Std. (18.5") Long (21.5") \$ std
1. Seat Width 14 15 16 17 18 \$ std
2. Seat Depth 12 13 14 15 16 \$ std
- Seat Depth 10 11 17 18 (Upcharge) \$ 150

BACKREST

3. Height (Adj. Range) 8 | 9 10 11 12 | 13 14 15 | (Adj. Range) 16 | 17 | 18 | \$ std
- Type Folding with adjust. height and angle \$ std
- NEW Locking mechan. (adjust. angle) \$ 150
- Welded with fixed angle _____° \$ 161

AXLE PLATE

- One Piece, Adjustable \$ std
- Camber Disc 10° 12° 14° 16° 18° 20° \$ std

- A. Cushion Thickness _____" 1"- 4"
- B. Camber Angle (0°-14°) _____°
- C. Lower Leg Length _____"
- D. Inside Wheel Clearance _____" 1" is std.
- E. Center of Gravity _____"
4. Front Seat Height _____" 14" - 21"
5. Rear Seat Height _____" 12" - 21" (w/24" rear wheel)
6. Overall Width _____"

- Base Wheelchair Price \$ 2,900
- Total Section A \$ _____
- Total Section B \$ _____
- Total Section C \$ _____
- Total Section D \$ _____
- Custom Modifications Quoted \$ _____
- Order Grand Total \$ _____

Custom Dimensions Available. Contact Colours For Details.

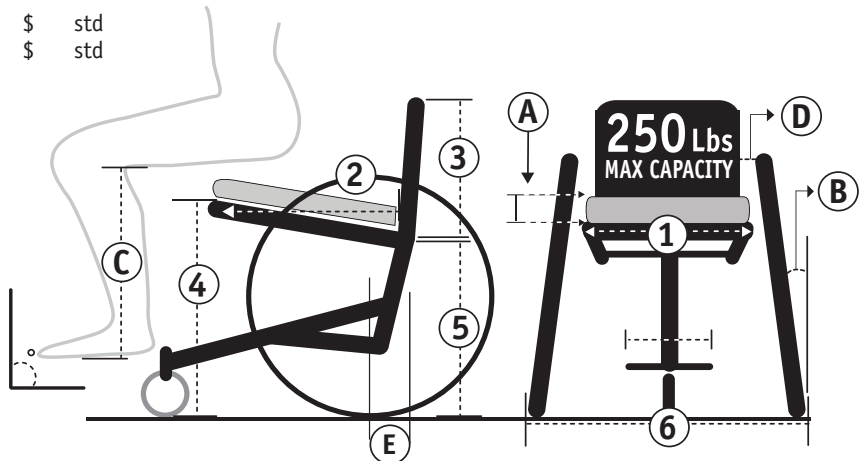

NOTES

B WHEELS & TIRES

- | | | |
|---|---|--------|
| <input type="checkbox"/> Standard Radial spoke wheel | <input type="checkbox"/> 24" <input type="checkbox"/> with black wall hi-press. tire <input type="checkbox"/> or standard low press. tire | \$ std |
| <input type="checkbox"/> Heat-Treated wheel * | <input type="checkbox"/> 24" <input type="checkbox"/> 25" <input type="checkbox"/> 26" | \$ 252 |
| <input type="checkbox"/> Cross Knot Laced Spokes (sport)* | <input type="checkbox"/> 24" <input type="checkbox"/> 25" <input type="checkbox"/> 26" <input type="checkbox"/> 27" | \$ 211 |
| <input type="checkbox"/> Twister Super Strength wheel * | <input type="checkbox"/> 24" <input type="checkbox"/> 25" <input type="checkbox"/> 26" | \$ 310 |
| <input type="checkbox"/> Spinergy SLX 18 spokes Sport * | <input type="checkbox"/> 24" <input type="checkbox"/> 25" <input type="checkbox"/> 26" Spokes <input type="checkbox"/> Black <input type="checkbox"/> Yellow <input type="checkbox"/> Blue <input type="checkbox"/> Red | \$ 743 |
| <input type="checkbox"/> E2213 Flat-Free Inserts (24 only) | <input type="checkbox"/> 24" | \$ 117 |
| <input type="checkbox"/> Solid tires | <input type="checkbox"/> 24" <input type="checkbox"/> 25" | \$ 135 |
| <input type="checkbox"/> E2211 Marathon tires High Press. | <input type="checkbox"/> 24" <input type="checkbox"/> 25" (All Black Tires) | \$ 99 |
| <input type="checkbox"/> Bite Laced Wheels with NEW locking hubs patent pending | <input type="checkbox"/> 24" or <input type="checkbox"/> 25" with h.p. tire | \$ 799 |

* Standard with black wall hi-press. tire and anodized handrims
Refer to Section D for more options!!

Section B Total \$ _____

X - T R E M E P R O ' 0 9
C O M P O N E N T S & A C C E S S O R I E S

C

Handrims

- Standard For 24", 25", or 26" Wheel Anodized Black Black Powder-Coated (Add \$65) \$ std
- Vinyl Coated Black \$ 142
- The Natural-Fit Handrim 24" or 25" with reg. grip or super grip +\$55 \$ 295
- The Natural-Fit Handrim (LT) 24" or 25" with reg. grip or super grip +\$85 \$ 325

Casters

- 3" Caster (black, clear, red) _____ \$ std

Push Handles

- Integrated w/ Fixed Backrest Height \$ 126

Seat

- Foam Cushion w/ Nylon Cover 1" 2" 3" 4" \$ 78
- The Curve Cushion (Rehab Co.) 3" \$ 133
- E0734 ROHO Cushion Quadtro 2" Low Profile 4" High Profile (USA only) \$ 525
- E0734 ROHO Nexus Spirit Cushion 2" Low Profile (USA only) \$ 525

Miscellaneous

- Custom Wheelie Bar w/Caster Single style (bolt-on) \$ 294
- E0971 Std. Anti-Tippers (pair) Quick Release \$ 112
- Welded Side Guards (ht. _____" length _____") no-adjustability to back angle - specify angle _____ \$ 450
- Rigid Side Guards - Black ABS (removable) or (non-remov.) CTW = cut to wheel \$ 142
- Rigid Side Guards - Alum. (removable) or (non-remov.) pol. alum blk. alum CTW \$ 197
- Fabric Clothing Guards Black Nylon w/Velcro \$ 78
- Frame Protectors Black Leather/Zipper type \$ 78
- K0108 Quad Wheel Quick Release Flip Up \$ 99
- K0065 Spoke Protectors 24" 25" 26" Black \$ 107
- Grab Handles pr. Left Right \$ 70
- Rear & Front Axles Rear - Quick Release Front - fixed bolts \$ std
- Front Axles Front - quick release \$ 107
- E0978 Seat Belt w/Auto Buckle 1 1/2" Belt \$ 69
- Colours Back Pack \$ 55
- Positioning straps Velcro one end Velcro both ends _____ Length \$ 85

Frame Colors (Powder-coated)

- Gloss Black Candy Blue White Yellow Metallic Gray Candy Red
- Twilight Flake Candy Purple Candy Green Fuschia Fire Engine Red Forest Green
- Midnight Blue Slime Green Midnight Purple Magenta Royal Blue Atlantic Blue
- Blue Green Gun Smoke Silver Matte Grey Matte Purple Matte Blue
- Matte Green Matte Red Matte Black \$ std

Custom Color (Custom Polished)

- Polished Alum. Frame Only \$ 800

Upholstery Choice & Color

- Standard Adjustable Ht. Black Black \$ std
- K0108 Adjustable Tension Backrest Black \$ 135
- Custom Colored (for std. or adjust. style) Red Blue \$ 60
- Fabrics for FUN (for std. or adjust. style) 001 002 003 004 010 011 014 015 016 017 018 019 020 021 022 023 024 025 026 027 028 \$ 95
- Backrest Leather Trim (outside panels) \$ 77

Section C Total \$ _____

☛ May not fit and function on all chairs depending on wheelchair configuration.

Everything should be as simple as it is, but not simpler. Albert Einstein

Colours in Motion warrants all rigid hardware for the lifetime of its registered owner. (Please see warranty registration card for details.)



D

EXTRA OPTIONS FOR ALL MODELS

Tire and Caster Options (installed on new chair ordered)

- Colored Tires High Pressure (pr) 24" 25" 26" Red Blue Yellow \$ 65
- 1.0 Wide Caster Wheels Alum. Hub (pr) 3" 4" 5" Black Hub Silver Hub \$ 160
- 1.5 Wide Caster Wheels Alum. Hub (pr) 4" 5" Black Red Blue Yellow \$ 160
- 1.5 Wide Caster Wheels Composite Hub (pr) 4" 5" Black Red Blue Yellow \$ 120

Other (installed on new chair ordered)

- Bicycle Plates with extra pair of axle receivers for Spazz, Blade, Chump and Zephyr \$ 250
- Wheelchair Tray (size avail.) 11" x 13" 13" x 15" 13" x 17" Raw Black Polish Alum. (Add \$250) \$ 250
- Ski Tips on Caster Forks \$ 275
- AZ-1 Portable Hand Controls \$ 349
- Anti Skid bar for rear of Boing! Spazz Krypto (not available w/anti-tippers) \$ 99
- Basketball Roller \$ 62
- One Arm Drive Custom Wheelchair (Zephyr, Spazz, Blade, Hammer, Chump) \$ CFP
- Heavy Duty Wheelchair for 300 or 350 lbs. (Spazz, Avenger, Eclipse) \$ CFP
- Tie Down Brackets 4pcs. Spazz, Chump, Spazz-G, Chump-G (Have been crash tested wc-19) \$ 210

Custom Paint Scheme (installed on new chair ordered)

- Polish All Parts excluding the frame \$ CFP
- Powder Coat bolt on parts \$ CFP
- 24 karat gold plating on various parts \$ CFP

Matching Gear (provide extras - installed on chair)

- Matching Fabric on Leg Strap - select fabric _____ \$ 55
- Matching Fabric on Padded Side Guards - select fabric _____ \$ 210
- Cushion Cover (Std. Cushion Only) - select fabric _____ Width ____ Depth ____ Thickness ____ \$ 90

Spare Parts (provide extras - not installed on chair)

- Colored Tires (pr) 24" 25" 26" Red Blue Yellow \$ 65
- Marathon SchwableTires (pr) 24" 25" Black \$ 80
- Knobby Tires/Tubes (pr) 24x1.375 mod. tread (Gray) 24x2.0 aggr. tread (Gray with Blue or Red Wall) 25x1.95 aggr. tread (All Black) \$ 120
- High Pressure Tubes (pr) 24" 25" 26" 27" \$ 12
- Bearings Rear Wheels or Caster Housing (set of 4) \$ 12
- Bearings for Caster Wheels (set of 4) \$ 10
- Quick Release Big Button Rear Axles (pr.) 4.5" 5.5" \$ 60
- KO108 Quad Wheel Quick Release Flip Up \$ 99
- Rear & Front Axles Rear - Quick Release Front - fixed bolts \$ std
- Front Axles Front - quick release \$ 107

Merchandise (provide extras - not installed on chair)

- Women S/S Tee S M L XL 2XL Black White Light Blue \$ 30
- Mens S/S Tee S M L XL 2XL Black White Gray \$ 30
- Caps Flex Fit S/M L/XL Black Gray \$ 24
- Beanies one size fits all Black Gray \$ 20
- Pillows with insert 14" x 14" Blk Flame Camo Girls Corazones High Speed \$ 55

Gear (provide extras - not installed on chair)

- Grab Bar Protector Removable (3/4" backrest tubing) \$ 35
- Wheel Bag 24" 25" 26" 27" \$ 350
- Colours Backpack (one size only) Black w/red logo Black w/blue logo \$ 55
- Positioning strap Velcro one end Velcro both ends _____ Length \$ 85
- Ratchet Strap small medium large \$ 125

Wheelchair Fingerless Gloves (pr.)

- Sport Grip Exec. Style Smooth Style \$ 29
- S M L

Section D Total \$ _____

CFP = Call For Price

☛ May not fit and function on all chairs depending on wheelchair configuration.

Everything should be as simple as it is, but not simpler. Albert Einstein

Colours in Motion warrants all rigid hardware for the lifetime of its registered owner. (Please see warranty registration card for details.)



**C O L O R S &
F A B R I C S**

ORDER FORM

COLOURS















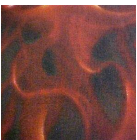





860 E. Parkridge Avenue, Corona, CA 92879
Tel: 951-808-9131 Fax: 951-808-9949
Toll Free: 800-892-8998 www.colourswheelchair.com

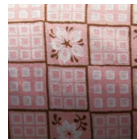

A C O L O R S

- | | | | | | | |
|---|--|--|---|--|--|---|
| <input type="checkbox"/> 
2 1 0 0
gloss black | <input type="checkbox"/> 
2 1 0 2
candy blue | <input type="checkbox"/> 
2 1 0 6
white | <input type="checkbox"/> 
2 1 0 9
yellow | <input type="checkbox"/> 
2 1 1 0
metallic gray | <input type="checkbox"/> 
2 1 1 1
candy red | <input type="checkbox"/> 
2 1 1 2
twilight flake-glitter flakes |
| <input type="checkbox"/> 
2 1 1 3
candy purple | <input type="checkbox"/> 
2 1 3 0
candy green | <input type="checkbox"/> 
2 1 4 1
fuschia | <input type="checkbox"/> 
2 1 0 5
fire engine red | <input type="checkbox"/> 
2 1 0 4
forest green | <input type="checkbox"/> 
2 1 0 1
midnight blue | <input type="checkbox"/> 
2 1 4 0
slime green |
| <input type="checkbox"/> 
2 1 0 8
midnight purple | <input type="checkbox"/> 
2 1 3 1
magenta | <input type="checkbox"/> 
2 1 3 2
royal blue | <input type="checkbox"/> 
2 1 3 3
atlantic blue | <input type="checkbox"/> 
2 1 3 4
blue-green | <input type="checkbox"/> 
2 1 3 8
gun smoke silver | <input type="checkbox"/> 
6 0 0 0
ball burnish polish alum. |
| <input type="checkbox"/> 
2 1 5 0
matte gray | <input type="checkbox"/> 
2 1 5 1
matte purple | <input type="checkbox"/> 
2 1 5 2
matte blue | <input type="checkbox"/> 
2 1 5 3
matte green | <input type="checkbox"/> 
2 1 5 4
matte red | <input type="checkbox"/> 
2 1 5 5
matte black | |

B F A B R I C S

- | | | | | | | |
|--|--|---|---|--|--|---|
| <input type="checkbox"/> 
F - 0 0 1
Black Flames | <input type="checkbox"/> 
F - 0 0 2
Camouflage Girls | <input type="checkbox"/> 
F - 0 0 3
Claws | <input type="checkbox"/> 
F - 0 0 4
Corazones | <input type="checkbox"/> 
F - 0 1 0
High Speed | <input type="checkbox"/> 
F - 0 1 1
Skulls On Fire | <input type="checkbox"/> 
F - 0 1 4
Skate Line |
| <input type="checkbox"/> 
F - 0 1 5
Flame Rider | <input type="checkbox"/> 
F - 0 1 6
Girls On Fire | <input type="checkbox"/> 
F - 0 1 8
Vegas | <input type="checkbox"/> 
F - 0 1 7
Dragon Tattoo | <input type="checkbox"/> 
F - 0 1 9
Islander | <input type="checkbox"/> 
F - 0 2 0
Wild Thing | <input type="checkbox"/> 
F - 0 2 1
Bloom |
| <input type="checkbox"/> 
F - 0 2 2
Curve Ball | <input type="checkbox"/> 
F - 0 2 3
Pink Lily | <input type="checkbox"/> 
F - 0 2 4
Pulling G's | <input type="checkbox"/> 
F - 0 2 5
Ruff Rider | <input type="checkbox"/> 
F - 0 2 6
Little Scouts | <input type="checkbox"/> 
F - 0 2 7
Virgin Mary | <input type="checkbox"/> 
F - 0 2 8
Lady In Red |

Valid From Jan '09. Prices & Specifications Are Subject To Change Without Notice.